

HOTWAT *Instant Hot Water System*



HOTWAT REGULAR
Simple, uncontrolled systems

HOTWAT PLUS
*A high integrity engineered system
for larger installations*

The Need for Instant Hot Water

Modern living dictates that buildings shall have hot water available whenever and wherever needed – and preferably instantaneously.

Hot water is normally provided by a boiler in a centralised or localised heating system.

After draw off of hot water at a supply point, the pipe feeding that supply point remains full of hot water which, under static conditions, cools to ambient conditions.

When demand resumes, there is a delay period whilst the now cold water is replaced by water heated from the boiler. The delay is both frustrating and costly, as the volume of the static head of water must effectively be heated each time a tap or valve is opened.



INSTANT HOT WATER
Traditional re-circulating system

Virtual instant hot water at taps was provided by a twin flow and return re-circulation system. The length of dead-legs was minimised so that hot water flowed soon after opening the tap, and so wastage was reduced.

This system has numerous shortcomings:

- the flow/return re-circulating pipework and thermal insulation has twice the capital and insulation costs compared with a single pipe system.
- heat losses from the flow/return re-circulation system are twice those of a single pipe system.
- maintenance costs are incurred with the introduction of pumps and other items having moving parts.
- dual pipe systems require twice the space.
- the system must be balanced.

HOTWAT

Instant hot water by single pipe hot water temperature maintenance

The HOTWAT single pipe temperature maintenance system overcomes ALL of the shortcomings of the re-circulation system.

The HOTWAT self-regulating heating cable is fitted to a single hot water supply pipe to maintain the hot water temperature by compensating for heat losses under no-flow conditions. Compared with a re-circulation system, this results in:

Reduced Capital Costs

- half the capital/installation costs of pipework/thermal insulation (the cost of the heat tracing system will usually be less than this saving).

Reduced Operating Costs

- half the pipework equals half the heat losses.
- maintenance free (no moving parts).
- half the space.
- no balancing required.

POWERTRIMMING

Variable temperature settings

Greater system flexibility is provided by the addition of variable system temperature settings. Where required, different parts of the building can be programmed to maintain different temperatures. Control is provided by a technique known as Powertrimming.

D-BUG

Thermal pasteurisation

The HOTWAT system can also be provided with D-BUG, a pasteurisation process whereby the static pipework system is periodically raised in temperature to disinfect the system.

Disinfection can be carried out automatically or manually.

CRUSADER

Circuit temperature scanning

The system control panel can include a CRUSADER circuit digital temperature scanning system to ensure optimum energy efficiency and power trim settings.

BMS INTEGRATION

HOTWAT can be tied into a BMS (Building Management System) for programmed temperature changes or thermal pasteurisation.

ECONOMICS POINT TO HOTWAT

Capital costs

The average 80% savings in the installation time and costs of a single pipe HOTWAT system will normally result in an overall capital investment saving of 10 – 25% compared with a re-circulation system.

Costs

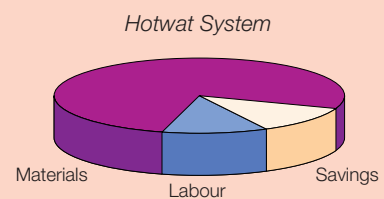
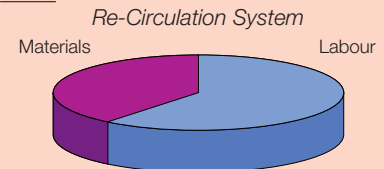

Operating costs

Half the pipework operating at reduced maintenance temperatures reduces energy consumption by an average 60%. Even allowing for higher fuel costs, total operating costs of a single pipe HOTWAT system will be 20 – 30% less than an equivalent re-circulation system.

Costs

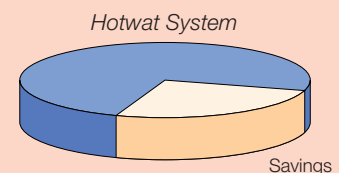
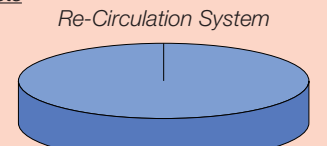

LEGIONELLA

HOTWAT reduces risks

Guidance to minimising the risk of Legionnaires disease is provided in Codes of Practice issued by the HSE (Document HS(G)70), CIBSE (TM3) and NHS Estates TM.2040.

The subject of heat tracing to reduce risks is addressed and in particular pasteurisation of the system by heat raising above the temperature at which bacteria is instantly killed is recommended by the HSE Code.

HOTWAT PLUS heating cable with Heat Trace's D-BUG timed thermal pasteurisation provides such a facility.

Systems and Applications

HOTWAT SYSTEM

HOTWAT systems are available for installation in all buildings provided with hot water services – from private dwelling houses, sheltered housing, offices, apartment blocks, commercial buildings, government centres, hotels and hospitals.

Systems vary from a simple uncontrolled fixed temperature installation, perhaps for smaller establishments, to high integrity, multi-temperature programmed, engineered installations, having options for automatic periodic thermal cleansing of Legionella bacteria and circuit temperature scanning.

As a company that specialises not only in the manufacture of heating cables, but also a wide array of bespoke control and monitoring electronic equipment, Heat Trace is ideally placed to provide the most appropriate HOTWAT system according to application conditions.

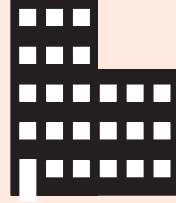
TYPE OF BUILDING		
Heating Cable Type	HWR-T	HWP-T
Hot Water Supply System	Localised or Centralised	Centralised
Temperature Control System	Fixed temperature	POWERTRIM variable control
Electrical Connection System (power, tee-splice, in-line splice, sensor connection)	HEAT-CLIP Connection Unit	HEAT-CLIP Connection Unit
Thermal Pasteurisation	Not Available	D-BUG timer unit or by BMS
Circuit Temperature Scanning (optional)	Not Available	CRUSADER temperature scanning and display system
Electrical Supply	230V nominal	230V nominal
Typical Maintain Temperature	55°C (131°F)	45 - 70°C (111°F - 158°F)
Heating Cable Nominal Output	9W/m at 55°C (29W/ft at 131°F)	12W/m at 65°C (39W/ft at 149°F)
Maximum Circuit Length	128m (420ft)	94m (308ft)
Maximum Exposure Temperature (1000 hours cumulative)	100°C (212°F) 80°C (176°F) energised	100°C (212°F) 80°C (176°F) energised
Minimum Installation Temperature	0°C (32°F)	0°C (32°F)
Circuit Breaker Size	20A	20A
Nominal Heater Dimensions	13.1 x 6.0 mm	13.1 x 6.0 mm
Heater Weight	13.2kg/100m	13.2kg/100m
Summary	HOTWAT REGULAR (HW-R) is a simple uncontrolled system that achieve the required maintain temperature when heater output is in thermal balance with pipe heat losses.	HOTWAT PLUS (HW-P) is a POWERTRIM controlled system which can be set to maintain a specific temperature for each heating circuit. It has the facility for automatic periodic thermal pasteurisation of the pipework by D-BUG or the BMS.

Design Guide

A HOTWAT system can be designed in 4 steps.

- STEP 1 - Determine heating cable type, and thermal insulation thickness.
- STEP 2 - Calculate heating cable length required.
- STEP 3 - Determine circuit protection and feed cable requirements.
- STEP 4 - Define the number of system components needed.

STEP 1

Selection of Heating Cable Type and Thermal Insulation Thickness

Select cable type HWR-T, or HWP-T according to whether a fixed or variable maintain temperature is required.

Nominal maintain temperatures are achieved based on insulation thicknesses given in the following tables:

System Type		Nominal Maintain Temp. (°C)	Thermal Insulation Specification/Thickness	Pipe size (mm)					
				15	22	28	35	42	54
HOTWAT PLUS	HWP-T	45 – 70 variable	Recommended (mm)	30	40	50	60	75	75
HOTWAT REGULAR	HWR-T	60 fixed	Recommended (mm)	25	30	40	50	60	75
		55 fixed	Recommended (mm)	20	25	30	40	50	60
		50 fixed	Recommended (mm)	15	20	25	30	40	50

STEP 2

Calculate the HOTWAT length needed

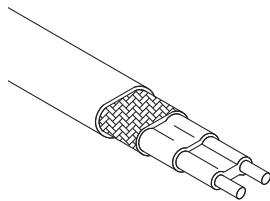

Use the following questionnaire to determine the total number of metres required for a HOTWAT installation.

Total pipework length	=	_____ m
<i>add</i> 0.25m per power connection	=	_____ m
<i>add</i> 1.0m per splice	=	_____ m
<i>plus</i> 2.5% allowance for cutting, wastage, etc.	=	_____ m
TOTAL CABLE LENGTH	=	_____ m

STEP 3

Determine circuit protection / power feed cable requirements

Over Current Protection and Maximum Recommended Circuit Length

Circuit protection is provided by Type C circuit breakers to EN60898:1991 or equal, sized as per the following table (based on 0°C start-up)

Circuit Breaker Size	Maximum Recommended Circuit Length	
	HWR-T	HWP-T
20A	128m	94m

$$\text{Minimum number of circuits} = \frac{\text{Total Cable Length}}{\text{Maximum Recommended Circuit Length}}$$

Hook-up Cables

Outer connecting cables from the controller to each circuit power connection must be correctly sized to satisfy Electrical Wiring Regulations and local/national standards or codes. Sizing is determined by the maximum allowable volt drop and current carried by the supply cable.

Generally, supply cables may be sized according to the following table.

MCB Type C or D Rating	Supply Cables Size (min)	Max. Supply Cable Length	
		HWR-T	HWP-T
20A	2.5mm ²	103m	60m

Important: A residual current device (rcd), 30mA is required.

STANDARD DESIGN PARAMETERS

HOTWAT systems can be provided for various design conditions. Information contained within this brochure is based on standard design parameters listed below.

Pipe materialCopper or Steel
 Building ambient temperature+ 18°C
 Thermal insulation K-value0.038W/mK at 36°C mid-point temp.
 Supply voltage230Vac

When other design parameters apply, contact your local Heat Trace Representative.

Design Guide / System Components

STEP 4

Determine System Components

HEAT-CLIP Universal connection unit

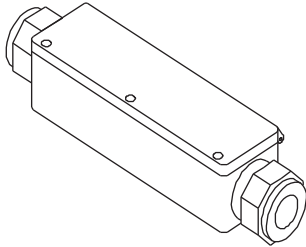

Ref: HC

HEAT-CLIP is a quick assembly connection unit providing the installer with a power, in-line and splice method of terminating HOTWAT heating cable.

The HEAT-CLIP can be used in any of the following ways:

- Power Connection for receiving one or two heating cables plus power lead.
- Tee-splice for receiving up to 4 heating cables
- In-line splice for receiving up to 4 heating cables
- Temperature sensor connection for receiving SENSOR A Pt100 temperature sensor and one control cable lead for wiring back to control panel.

Overall dimensions (inc glands):
235mm(L) x 60mm(W) x 50mm(H)

End Seal

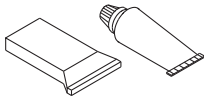

Ref: BES3/RTV

End seal for terminating the remote end of the heating cable.

Overall dimensions:
50mm x 16mm x 8mm

Number required:
1 per each end of circuit

Tie Wraps

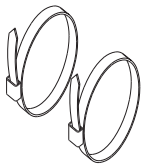

Ref: NT/SF

The HEAT-CLIP requires tie wraps to fix the mounting bracket to the pipework.

(The tie wraps fit between the gland and the body of the HEAT-CLIP)

Number required:
2 per HEAT-CLIP

Fixing Tape

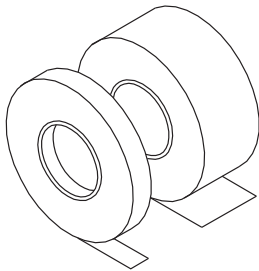

Ref: FT/HTP
(Copper / Steel Pipe)

Adhesive tape in 33m rolls for fixing HOTWAT heating cable with circumferential ties at 300mm centres.

Number of rolls of FT/HTP per 100m of pipe:

Pipe Size (mm)	15	22	28	35	42	54
No. of rolls	2	2	3	3	4	4

Ref: FT/ALUM
(Plastic / Stainless Steel Pipe)

Aluminium adhesive foil tape in 45m rolls for fixing HOTWAT heating cable longitudinally along its entire length

Number required:
1 roll per 45m of pipework.

Warning Label



Ref: CL

'Electric Heat Tracing' warning label for fixing by insulation contractor at 6m intervals to outside of insulation cladding.

Number required:
1 label every 6 metres of pipework.

Control Equipment

HOTWAT REGULAR is basically an uncontrolled systems where the heat output from the heating cable is in thermal balance with heat losses from the pipework.

This occurs at a maintain temperature of 50 - 60°C (HWR-T) within a building at 18°C for the standard and reduced specifications respectively.

The only control devices required for a HWR-T system is over current circuit breakers and earth leakage protection devices, as provided in our Local Distribution Panels shown below.

HOTWAT PLUS is a high integrity engineered system. The control items would normally be incorporated within a custom built local display panel providing over current protection and earth leakage protection.

D-BUG Timing Unit

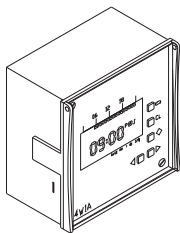

Ref: DB-02

The D-BUG timing unit periodically over rides the PT-01, or PT-02 POWERTRIM unit in order to either:

- i) apply full power for thermal pasteurisation of the piping system when used with HOTWAT PLUS heating cable, or
- ii) switch off the system, eg. week-end shut-down.

D-BUG has a 7 day programming and battery back-up.

Number required:
1 unit is required per 20 circuit installation.

If the POWERTRIM is to be over-ridden by the Building Management System (BMS), the D-BUG timer unit is not required.

Dimensions: 88mm x 43mm x 60mm

POWERTRIM Power Control Units

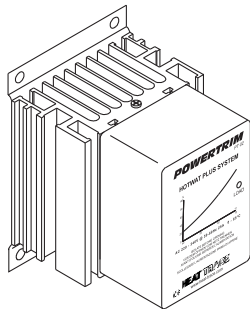

Ref: PT-02 (or PT-02/T)
Single Channel Power Control Unit with optional built-in D-BUG timer unit (25A maximum capacity)

The PT-02 is a single circuit power control unit which can be set to maintain a HOTWAT PLUS system within the 45°C-70°C temperature range. Unit has its own output drive.

The optional built-in D-BUG timer unit can be programmed to override the POWERTRIM unit for thermal pasteurisation of piping system (maximum 1 hour per week).

Number required:
1 per 44m HWP-T heating tape

Dimensions: 95 x130 x 110mm

Ref: PT-01
Multi-Channel Power Control Unit

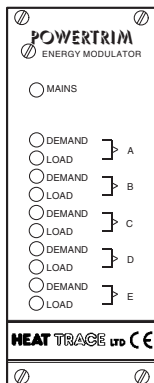

- A five channel power control unit.
- Each channel can be set to maintain a different temperature within the 45-70°C range.
- Each channel can control up to 6 solid state output drive.
- Each solid state switch can control a number of individual HOTWAT heating circuits.
- Powertrim is designed for fitting into a 19" rack.

Therefore, a 5-channel POWERTRIM can control from one, to thirty solid state switches, in 5 different temperature groups. A maximum of 100m of heater can be supplied from a single outgoing circuit.

Maximum number required:

$$= \frac{\text{number of heating groups}}{30}$$

Facia dimensions: 50mm x 128.5mm

A single POWERTRIM unit is usually sufficient for most large installations.

Solid State Switching Devices

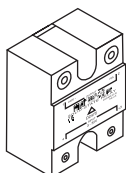

for use with PT-01 POWERTRIM

Each heating zone is switched via a panel mounted solid state relay.

Number required:
up to 6 per active PT-01 channel

CRUSADER Digital Temperature Scanning and Display Unit (optional)

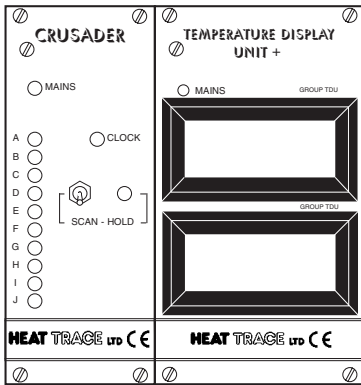

Ref: CRU**
 TDU (Single Temp. Display)
 TDU+ (Dual Temp. Display)

When required, a Pt100 sensor can be installed to monitor the temperature of each, or selected heating circuits or zones.

CRUSADER is a temperature scanning system which can scan up to 10 channels.

Each circuit temperature is displayed sequentially on the TDU digital display. A single display is available for up to 10 channels, and a dual display is available for 11 - 20 channels. (Two CRUSADER'S required).

eg. 18 circuit system to be monitored.
 Equipment required:

1	CRU10	10 channel CRUSADER
1	CRU08	8 channel CRUSADER
1	TDU+	Dual temperature Display Unit
18	SENSOR A	Pt100 Temperature Sensors
18	UB	UNI-Box connectors
18	PB/UB	Mounting bracket for UNI-Box connector

** Denotes the number of channels to scan.

Pt100 Temperature Detector

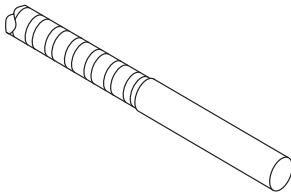

Ref: SENSOR A

Glanded Pt100 sensor for use with the UNI-Box connection unit.

Item is optional. For use with CRUSADER temperature scanning and display unit.

Number required:
 1 for each temperature sensed length of pipework.

Dimensions (bulb):6mm dia x 50mm long

Building Management System (BMS)

HOTWAT PLUS can interface directly with the BMS and avoid the need for Heat Trace's D-BUG timing unit.

pasteurisation of the pipework. This may be applied, for example, for three hours (minimum) when there is little demand for hot water; eg. weekends, nights, etc.

The BMS will automatically override the POWERTRIM control unit at appropriate times to apply full power for thermal

Local Distribution Panel

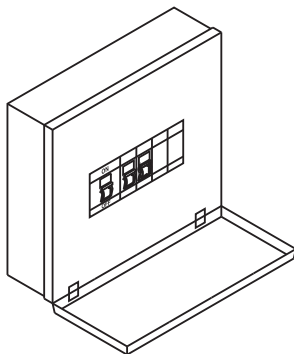

The distribution panel is selected according to the number of circuits calculated at STEP 3. Each panel is provided with a 20A single phase circuit breaker for each outgoing circuit. A ground fault protection device is fitted, sensitivity 30mA, 30ms for protection of all circuits. The LDP is also provided with a main incoming isolator.

Standard panels are:
 LDP-03/1P/20 for up to 3 x 20A, 230V circuits, single phase incoming feed.
 LDP-06/3P/20 for up to 6 x 20A, 230V circuits, 3 phase & neutral incoming feed.
 LDP-09/3P/20 for up to 9 x 20A, 230V circuits, 3 phase & neutral incoming feed.

The LDP is rated IP54 for internal use. It should therefore be suitably weather protected if installed outdoors.

Number required:
 1 per system of up to 9 circuits or 9 x 20A groups of heaters

Installation

Typical HOTWAT LITE / REGULAR Installation

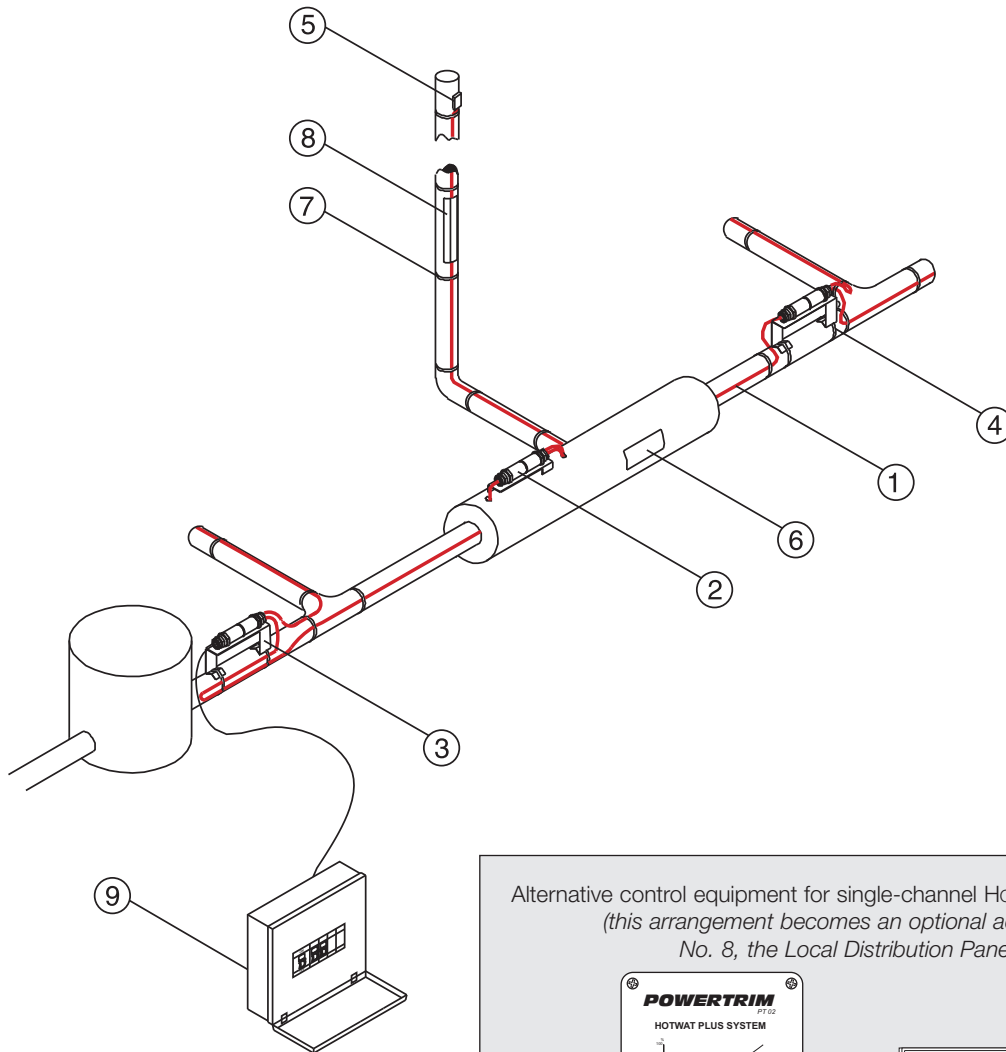

- 1 HotWAT Heating Cable
- 2 HEAT-CLIP Connection Unit
- 3 Tie Wraps
- 4 End Seal
- 5 Caution Label
- 6 PVC Fixing Tape
- 7 Aluminium Fixing Tape

Optional Items

- 8 Local Distribution Panel
- 9 D-BUG Timer Unit
- 10 PT-02 Single-Channel POWERTRIM Control Unit (PT-02/T available as an option)
- 11 PT-01 Five-Channel POWERTRIM Control Unit
- 12 Solid State Switching Devices
- 13 CRUSADER Temperature Scanning Unit
- 14 Dual Temperature Display Unit

SENSOR A Pt100 Temperature Detector (not shown)

Alternative control equipment for single-channel HotWAT PLUS System
(this arrangement becomes an optional addition to No. 8, the Local Distribution Panel)

Not required if PT-02/T is used instead of PT-02

illustrations shown are not to scale

Alternative control equipment for multi-channel HotWAT PLUS System
(this arrangement becomes an optional addition to No. 8, the Local Distribution Panel)

illustrations shown are not to scale

Typical Wiring Arrangement Schematics

Typical HOTWAT LITE or HOTWAT REGULAR system

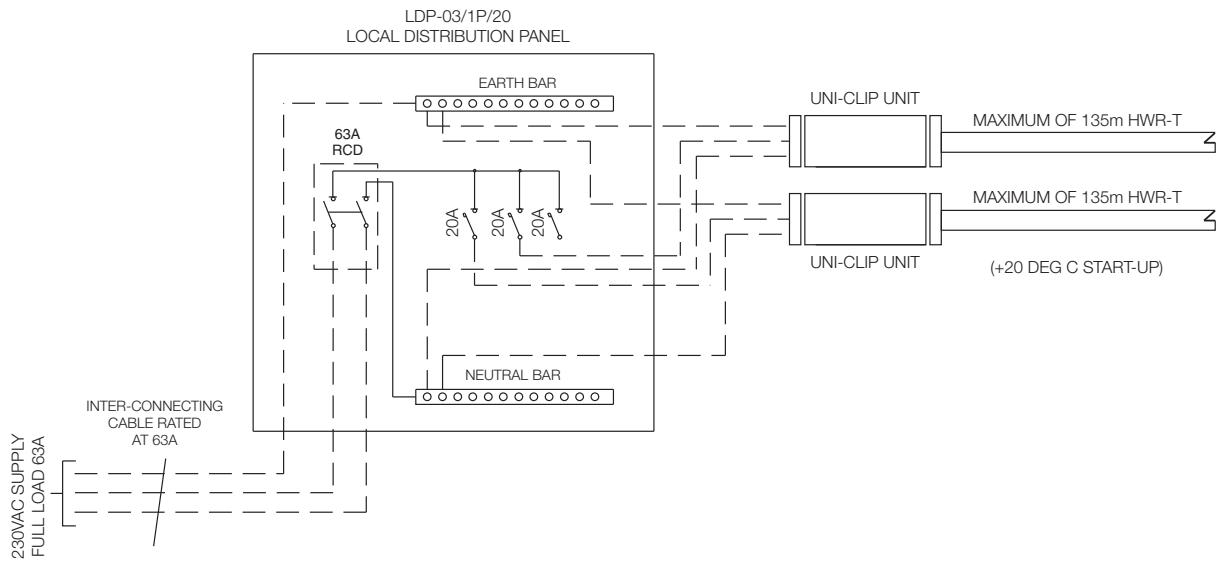

Typical HOTWAT PLUS system using PT-02 POWERTRIM

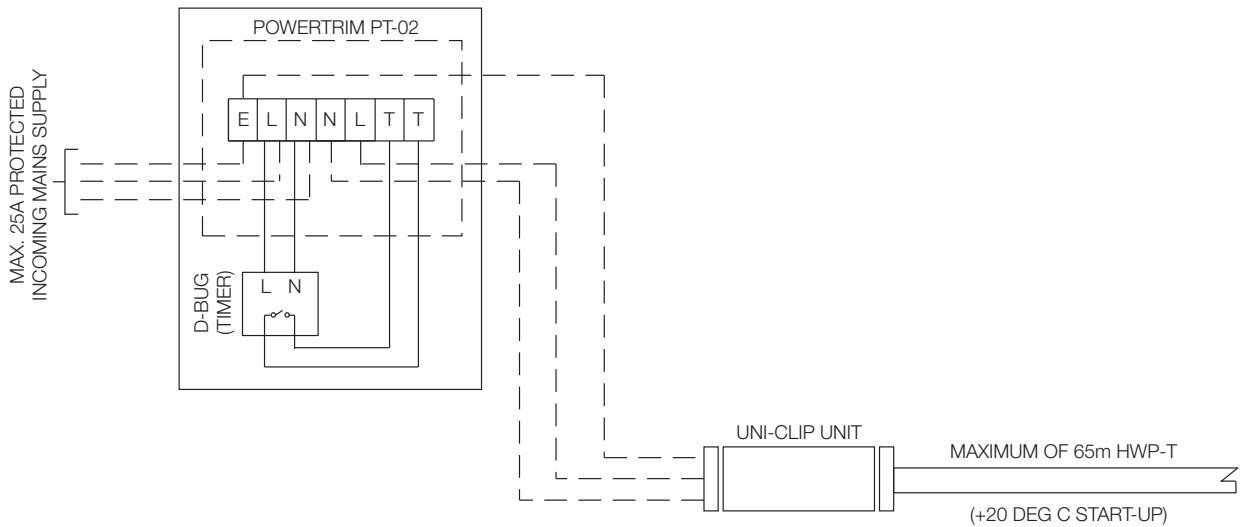

HOTWAT PLUS system using PT-01 POWERTRIM

For large, multiple circuit installations, PT-01 will probably be the most appropriate system when thermal pasteurisation is specified.

Consult your local Heat Trace Representative for your particular schematic wiring diagram

Bill of Materials - Order Form

CUSTOMER NAME AND ADDRESS:

 Contact: _____
 Tel: _____
 Fax: _____
 Order Number _____
 Order Date / / Date Required / /

SUPPLIER DETAILS:

 Tel: _____
 Fax: _____

QUANTITY	TYPE REF.	DESCRIPTION	UNIT PRICE	EXTENDED
m	HWR2-T	HOTWAT REGULAR Heating Tape, 230V	_____	_____
m	HWP2-T	HOTWAT PLUS Heating Tape, 230V	_____	_____
pcs	HC	HEAT-CLIP Connector	_____	_____
pcs	BES3/RTV	End Seal complete with silicone sealant	_____	_____
pcs	NT/SF	Tie Wraps (2 required per HC)	_____	_____
pcs	FT/HTP	PVC Fixing Tape	_____	_____
pcs	FT/ALUM	Aluminium Fixing Tape	_____	_____
pcs	CL	Caution Labels	_____	_____
pcs	LDP-03/1P/20	3 x 20A S.P. circuits, single phase incoming feed	_____	_____
pcs	LDP-06/3P/20	6 x 20A S.P. circuits, TP&N incoming feed	_____	_____
pcs	LDP-09/3P/20	9 x 20A S.P. circuits, TP&N incoming feed	_____	_____
pcs	DB-02	D-BUG Timer Unit	_____	_____
pcs	PT-02	Single Channel POWERTRIM Control Unit	_____	_____
pcs	PT-02/T	as above but with built-in D-BUG Timer Unit	_____	_____
pcs	PT-01	Five Channel POWERTRIM Control Unit	_____	_____
pcs	_____	Solid State Output Drive for use with PT-01 <i>contact your local Heat Trace Representative for guidance</i>	_____	_____
pcs	CRU__	CRUSADER Scanning System, __ Circuit System	_____	_____
pcs	TDU	Temperature Display Unit, Single / Dual *	_____	_____
pcs	SENSOR A	Pt100 RTD Sensor	_____	_____
			SUBTOTAL	£_____
			C & P	£_____
			VAT	£_____
			TOTAL PRICE	£_____

HOTWAT PLUS Systems Only

Note:
 TP&N: Three phase and neutral
 * Delete where appropriate
 Additional materials needed to complete the heat tracing installation:
 ● All mains and interconnecting cables/glands
 ● Thermal Insulation

Fax this order form to your Local Representative shown above



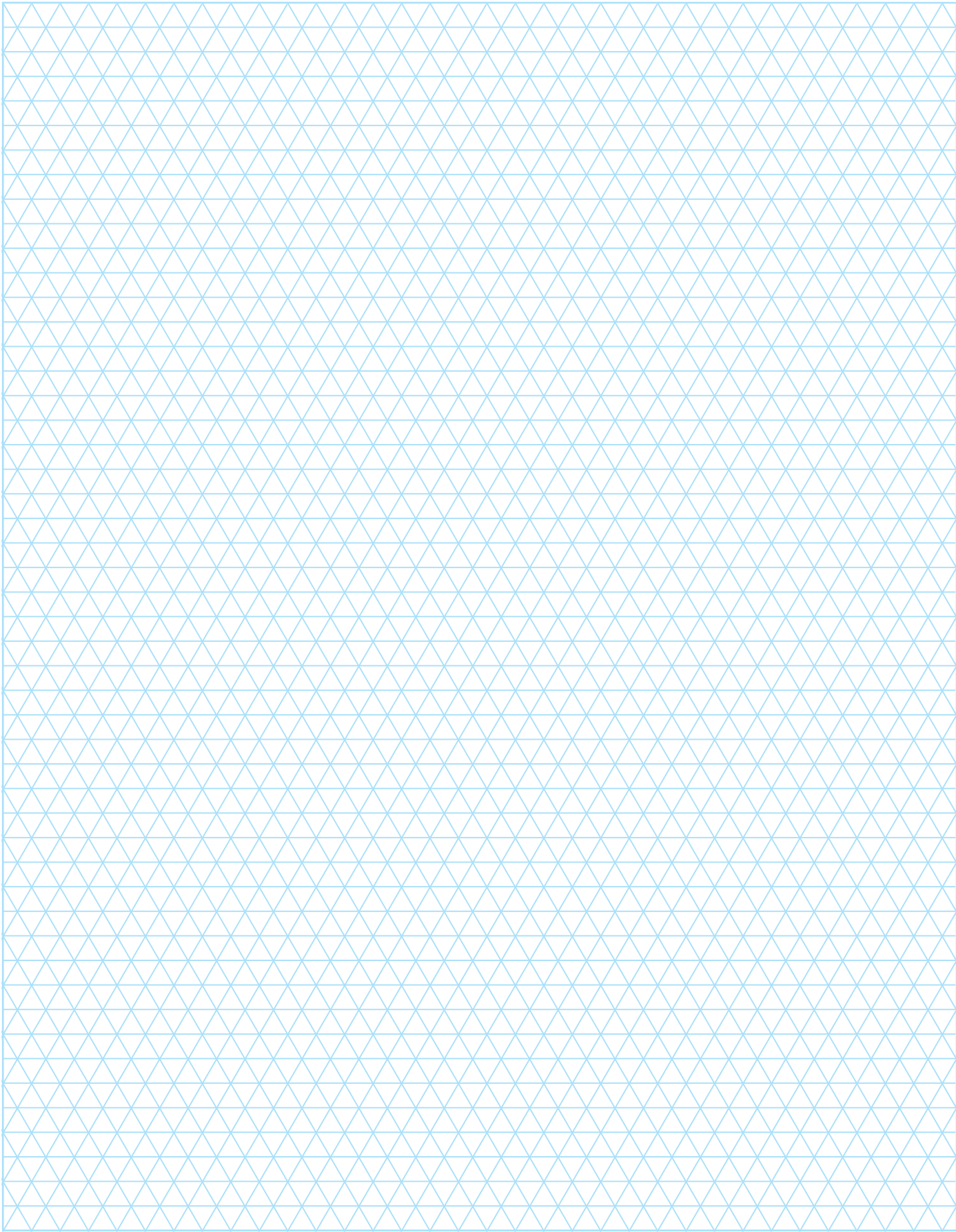

Presented by:



BS EN ISO 9001

Certificate No. 0160



Mere's Edge, Chester Road, Helsby, Frodsham, Cheshire, WA6 0DJ, UK.
Tel: +44 (0)1928 726 451 Fax: +44 (0)1928 727 846 www.heat-trace.com

The information given herein, including drawings, illustrations and schematics (which are intended for illustration purposes only), is believed to be reliable. However, Heat Trace Ltd makes no warranties as to its accuracy or completeness and disclaims any liability in connection with its use. Users of Heat Trace Ltd products should make their own evaluation to determine the suitability of each such product for specific applications. In no way will Heat Trace Ltd be liable for any damages arising out of the misuse, resale or use of the product.